

SEISMIC REQUIREMENTS

Essential Facilities Nonstructural Cold Formed Steel Design Solutions

TSN has made substantial strides in developing code compliant connections and members that focus on the Nonstructural component design. These components are being used in projects that comply with the new mandates for seismic design.

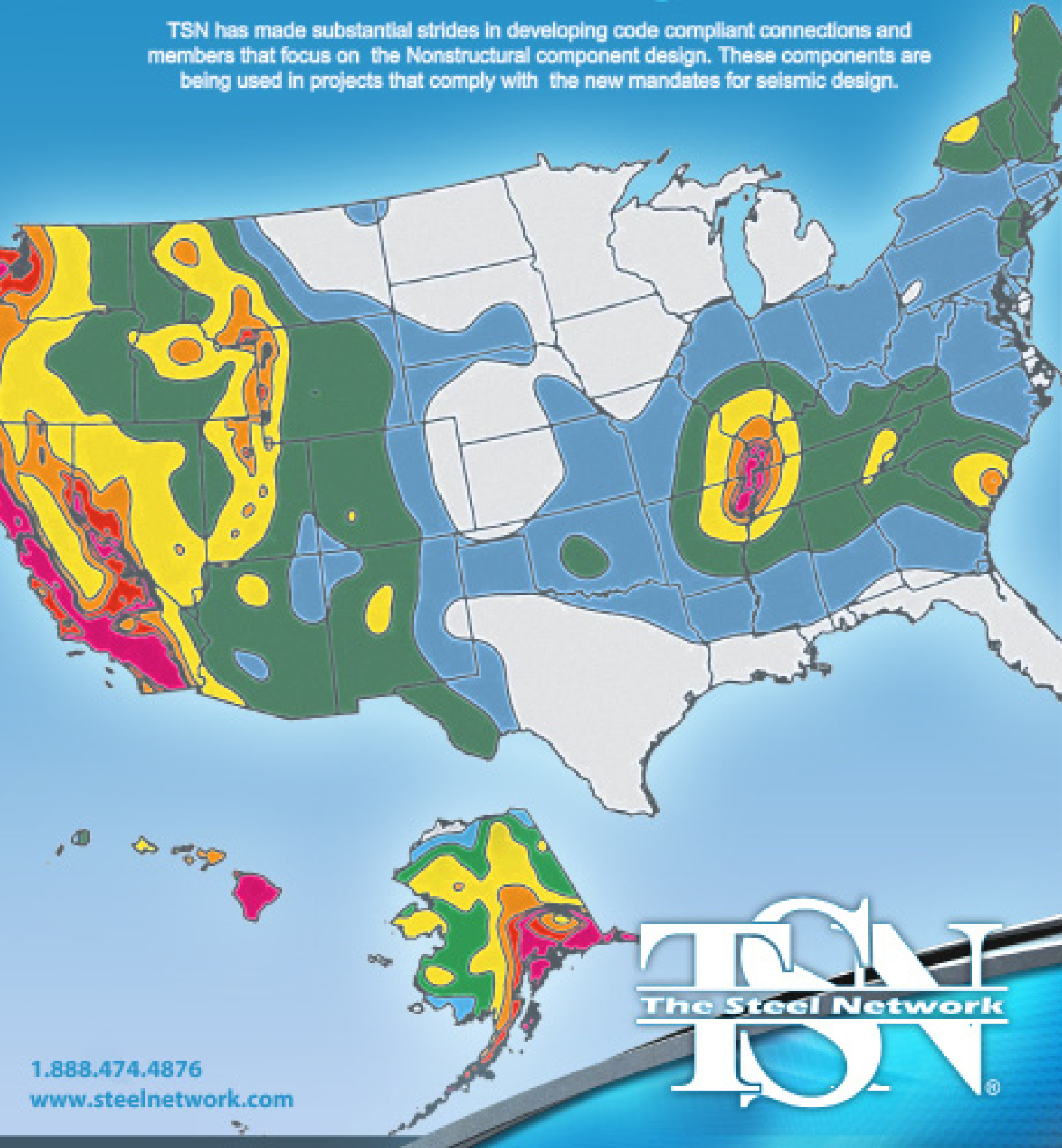

1.888.474.4876
www.steelnetwork.com

TSN
The Steel Network
TSN

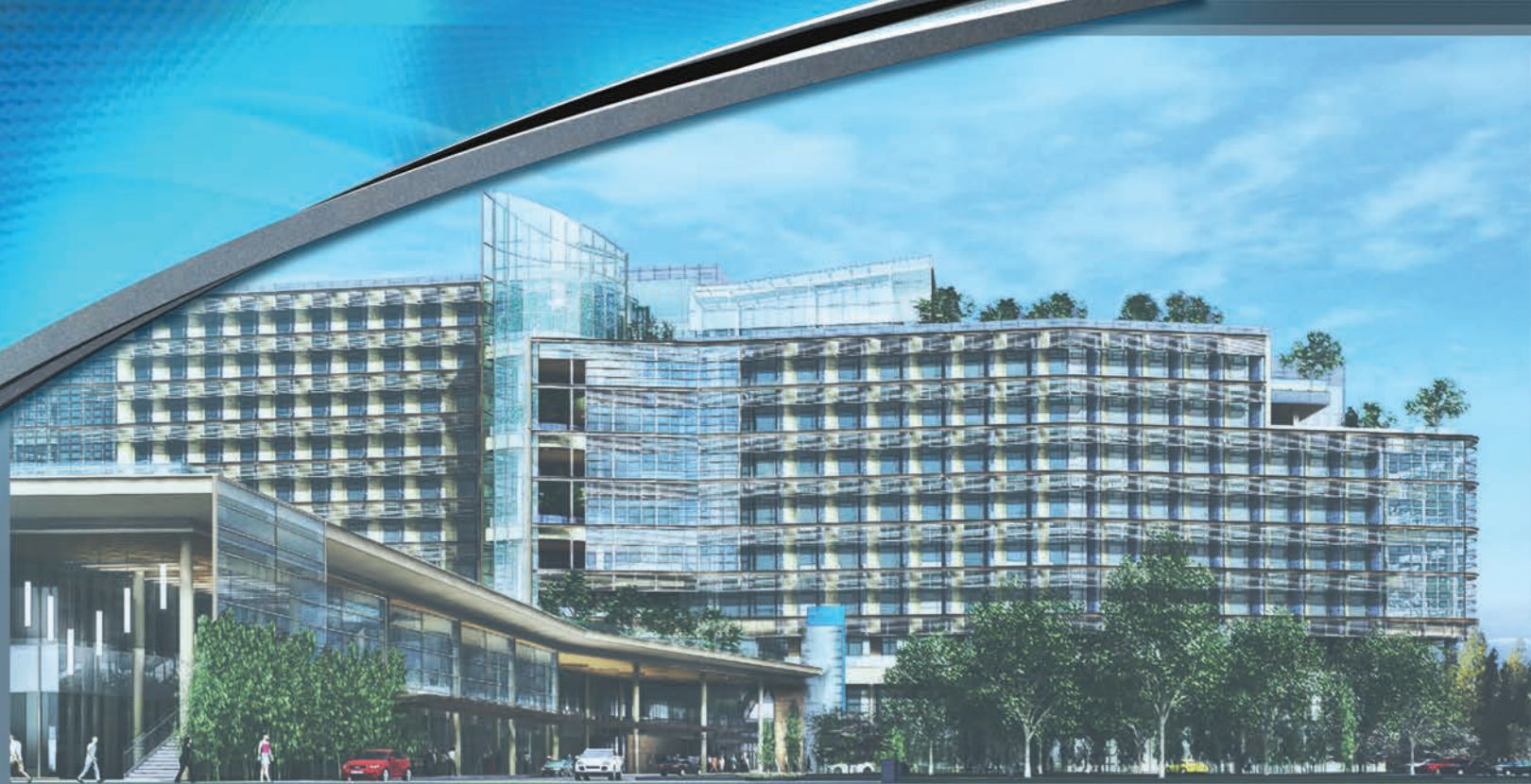

Project Showcase:

Palomar Pomerado Hospital

2185 Citracado Parkway, Escondido, California

The Steel Network's JamStud® was used on one of the largest Hospital projects in the state of California.

The Palomar Pomerado Hospital design team replaced multiple built-up studs and tracks at interior and exterior openings with a single TSN JamStud®. JamStud® was also used to replace tube steel in ribbon windows.

Replacing the built-up sections with a TSN JamStud® resulted in a 40% material savings. Also the use of TSN JamStud® offered additional cost savings in labor.

TSN offered a preliminary design analysis that showed the potential savings TSN would be able to offer this project. This complimentary engineering and budget analysis helps to maximize material and installation efficiency on a project. For this complimentary analysis contact a member of TSN at 1-888-474-4876.



40% Materials Saved



JamStud®

The Simple Choice to Increase Your Production

- JamStud® from The Steel Network is readily available from distributors throughout the Nation.
- One JamStud® can replace 2 or more “C” studs or even a box beam header!
- TSN’s Tech Support Team will help you determine the optimal size for your project.
- Reducing materials also reduces thermal conductivity. “Green” your project by using JamStud®!

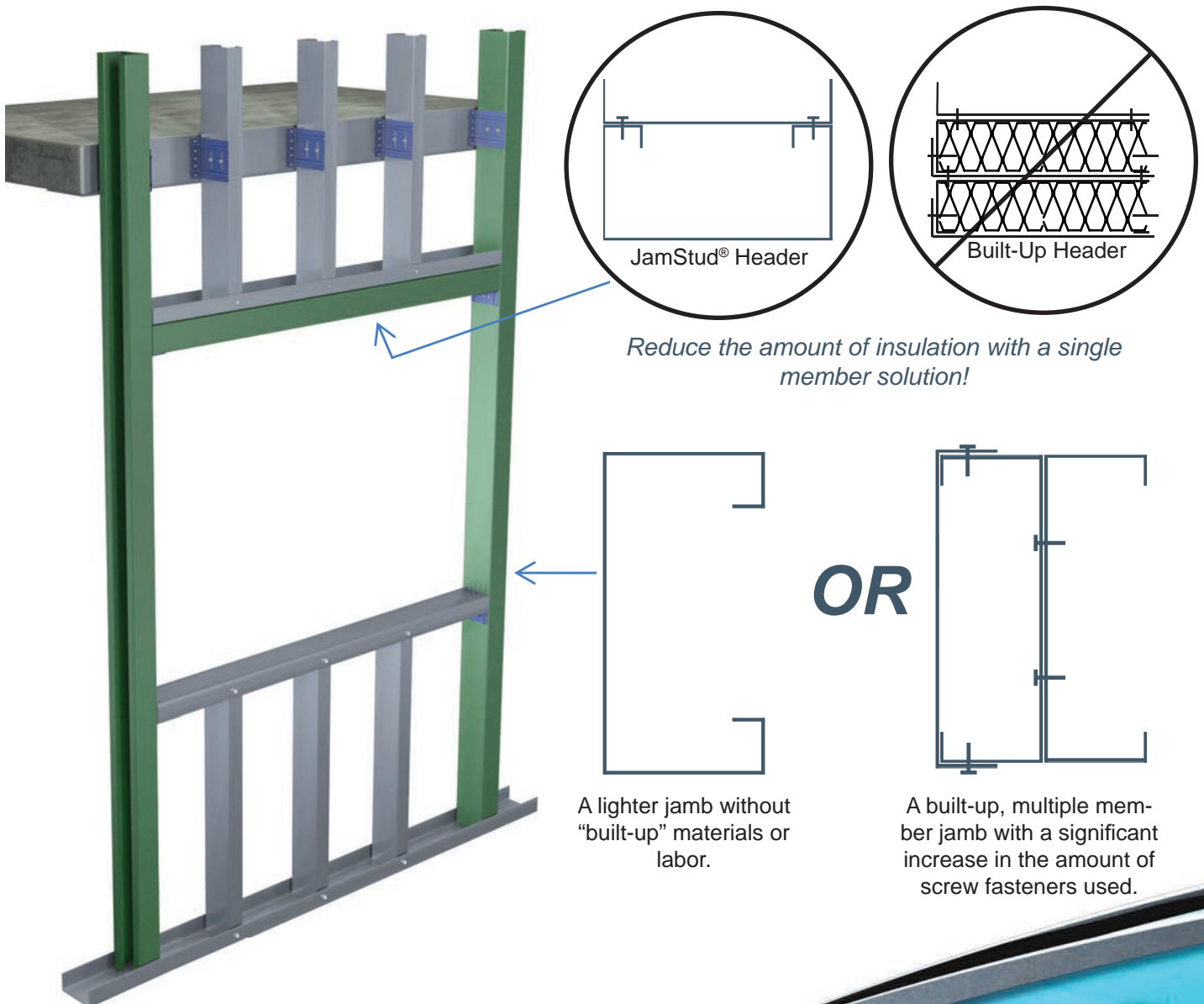

JamStud®

For Wall Opening Seismic Design

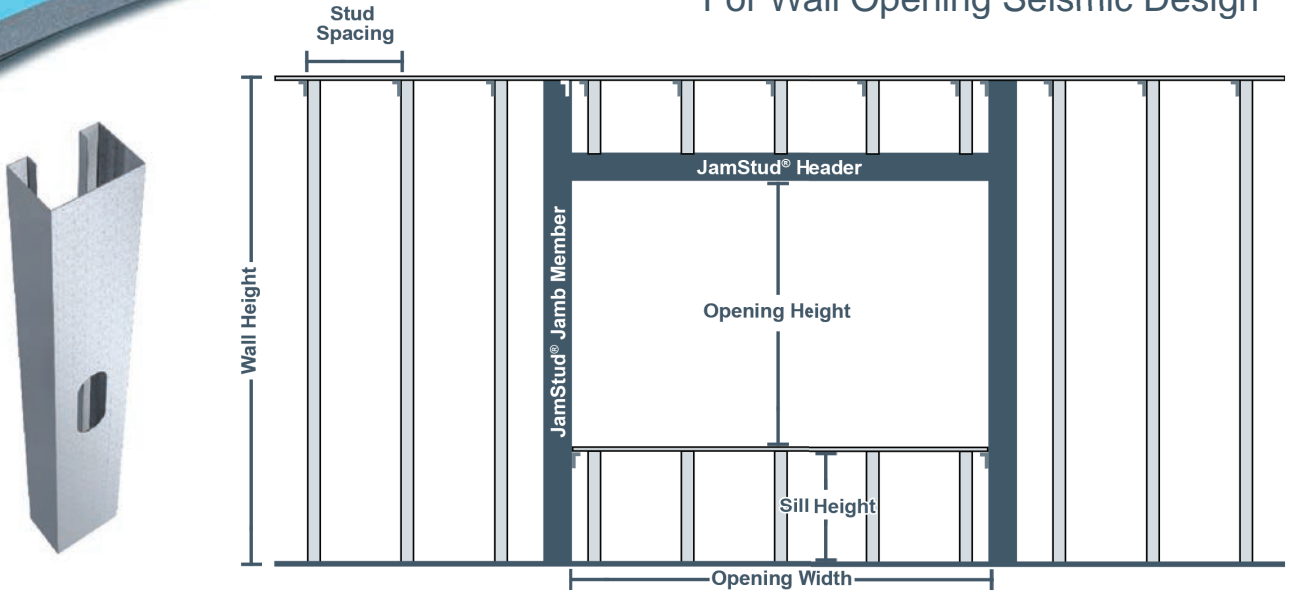

Design Case	Typical Wall Stud	JamStud® Solution		Typical Built-Up Jamb	
		Section	Shape	Section	Shape
Wall Weight = 15 psf SDS = 1.128 Interior Condition Wall Width = 4" Opening Type Window Window Width = 6' Window Height = 5' Sill Height = 4" Wall Height = 13' 0" Deflection Limit = L/240	400S162-43	Single 400JS250-54		(2) Studs 400S162-43, attached at 24" o.c. vertically, capped with a closure Track 400T150-43 for window frame attachment	
Wall Weight = 15 psf SDS = 1.128 Interior Condition Wall Width = 4" Opening Type Door Door Width = 4' Door Height = 7' Wall Height = 16' 0" Deflection Limit = L/240	400S162-54	Single 400JS250-68		(2) Studs 400S162-54, attached at 24" o.c. max. vertically, capped with a closure Track 400T150-43 for window frame attachment	
Wall Weight = 40 psf (brick) SDS = 1.128 Exterior Condition Wind Load = 20 psf Wall Width = 6" Window Height = 5' Window Width = 6' Sill Height = 4" Wall Height = 13' 0" Deflection Limit = L/600	600S162-54	Single 600JS350-68		(2) Studs 600S162-54, attached at 24" o.c. max. vertically, capped with a closure Track 600T150-68	



Head of Wall



DriftClip® DSLD



DriftClip® DSL



DriftClip® DTSL

Bypass

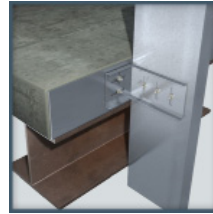

DriftClip® DSLB



DriftClip® DSLS



DriftClip® DTSLB

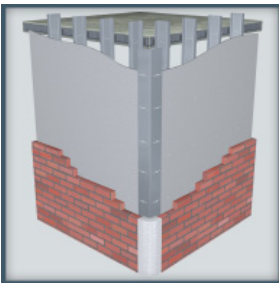

DriftCorner®

DriftCorner® in conjunction with the DriftClip® or DriftTrak® series helps provide complete solution to both vertical deflection and lateral movement of the structure.

DriftClip® Value

- Positive, load rated mechanical attachments
- Manufactured from mill-certified, 50ksi steel
- Step Bushings pre-installed for accurate placement
- Rated screws provided for attachment to stud web
- Load transferred from stud web
- Meets all building code criteria
- Adaptable for multiple configurations

DriftClip® Seismic Code Compliance

TSN DriftClip® products contain a ICC-ES Evaluation Report, ref. ICC-ESR-2049. Attachment to stud is made using self drilling screws. For attachment to structure varying project design conditions require a number of differing fastener requirements.

For bypass connectors to steel (fastener in tension): Per ASCE 7-05, Section 13.4.4, Power actuated fasteners shall not be used for tension load applications in Seismic Design Categories D,E, and F unless approved for such loading. Presently, approved PAF's are not available. For this condition a self drilling screw or weld attachment is required.

For bypass connectors to concrete (fastener in tension): Fasteners in seismic conditions require rating for cracked concrete. The smallest diameter fastener rated for such conditions is 3/8". Standard TSN bushings for attachment to structure are sized to accommodate a 1/4" diameter fastener. For this condition a special step bushing can be provided to accommodate a 3/8" fastener.

For infill connectors to concrete or steel (fastener in shear): A number of fastener options are available including: paf, screw, or weld in some cases. Standard TSN bushings for attachment to structure are sized to accommodate a 1/4" diameter fastener. For additional information regarding alternative fastener options contact TSN at (888) 474-4876.



A Los Angeles Research Report for DriftClip® DSLD, DSL, DSLB, DSLS, DriftTrak DTSL and DTSLB Series is available. Refer to LARR #25781.



An ICC-ES Evaluation Report for DriftClip® DSLB, DSL, DSLS, DriftTrak® DTSLB and DTSL is available. Refer to ICC-ESR-2049 at www.icc-es.org or at www.steelnetwork.com



MidWall™

Base Connector for Partial (Knee) Walls

MidWall™ is one of The Steel Network's latest in a long line of enhancements to the metal framing industry, providing a tested alternative in partial wall assemblies. It is a revolutionary product intended to simplify and optimize the design and construction of a short wall or half wall in residential and commercial cold formed steel framing. Available in widths of 2 1/2", 3 5/8" or 6" and lengths of 24" or 48", MidWall™ is a one piece connection/framing unit which provides for optimization of materials and streamlined installation. A MidWall™ may be used as a cost effective solution to several common construction conditions including interior half walls, strip window framing, and parapet framing.

MidWall™ is designed to support out-of-plane loading in cantilevered partial wall systems that are unsupported at the top track. The out-of-plane loads are transferred to the floor system through a 1/2" thick plate nested in the flanges of the member with two 3/8" diameter fasteners used for the connection. Available in two lengths, 24" and 48", MidWall™ may be used in place of standard framing members, or in conjunction with them to frame the wall.

MidWall™ 24" Assembly Example



MidWall™ 48" Assembly Example

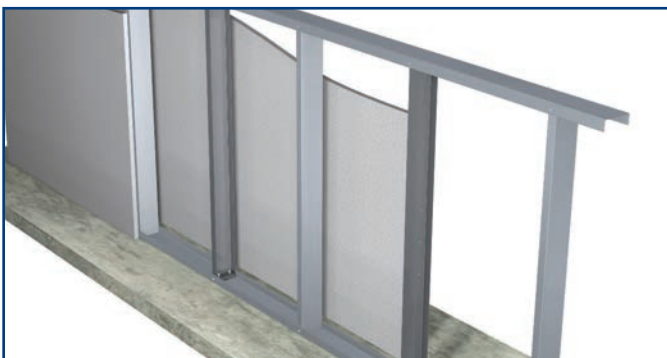

MidWall™ VS Tube Steel

- Replaces traditional Tube Steel with a base plate used in cantilevered walls.
- Reduces the number of anchors used (2 in MidWall™ vs. 4 in other methods)
- Provides guide holes for attachment of MidWall™ to the stud
- Creates flexibility as two sizes of MidWall™ are available (24" and 48") to enable adjustable wall heights
- Meets current code requirements for handrails and partial walls
- Resists higher loads in parapets

Ribbon Window

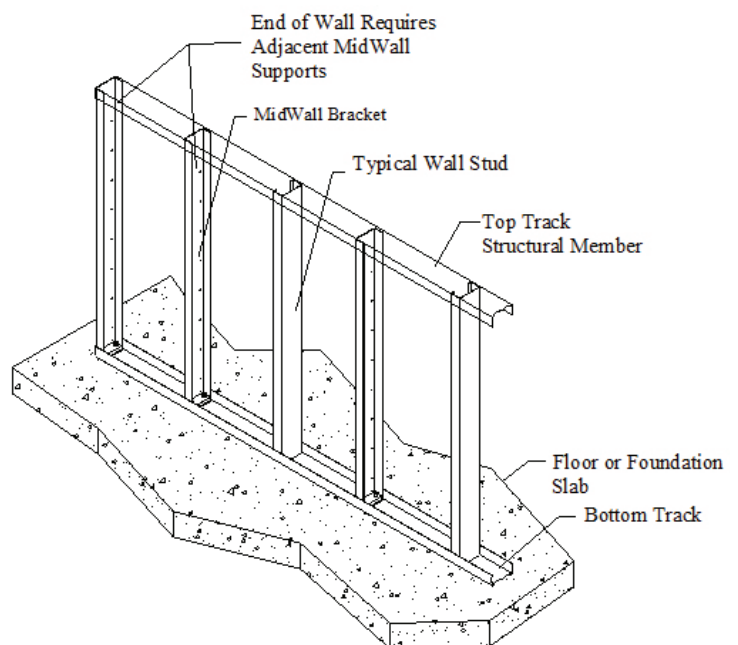
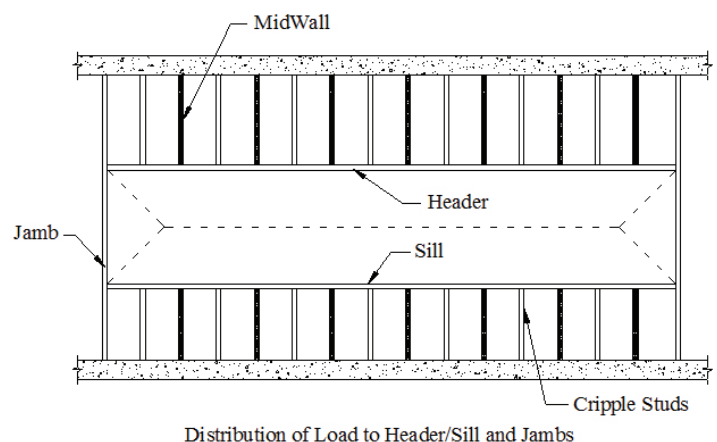

BackIt® Wall Backing Support Connector

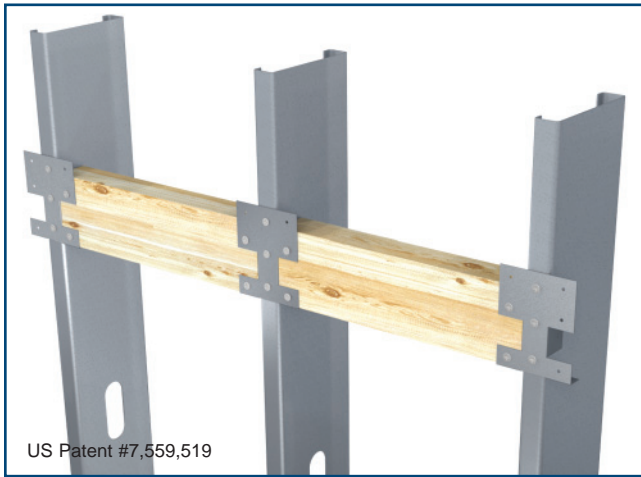

US Patent #7,559,519

BackIt® provides a solid backing solution to support handrails, wall-mounted shelving, and other equipment. Installation is greatly simplified through a simple screw connection to the stud flange, delivering a flexibility for use in 12", 16", and 24" stud spacing. Shelf tabs hold a variety of wood backing sizes and shapes, including 1" x 6", 2" x 4", and 2" x 6", in place during installation. BackIt® exceeds code-required allowable load resistance of 250lbs in the vertical and horizontal directions.

BackIt® Value

- Guide holes for stud and wood attachments
- Shelf tabs to rest wood upon during installation
- No pre-determined stud layout
- May be used with multiple sizes of wood
- Resists load in the directions recommended by codes

BackIt® Installation



Place clip flush against wall stud flange and attach to stud with required amount of approved fasteners. Fastener amounts may vary by application.

Rest wood piece on shelf legs and attach to clip with required number of screws through guide holes. For higher loads, attach BackIt® to the stud web through a guide hole in the interior leg.

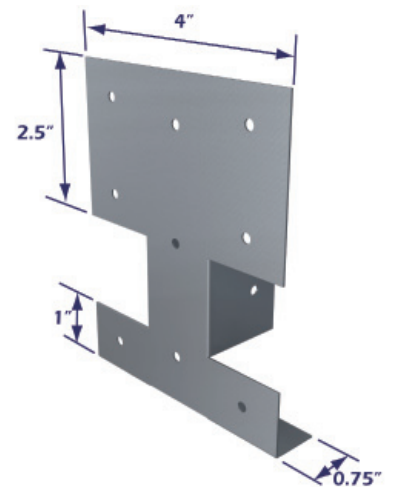

Load Direction

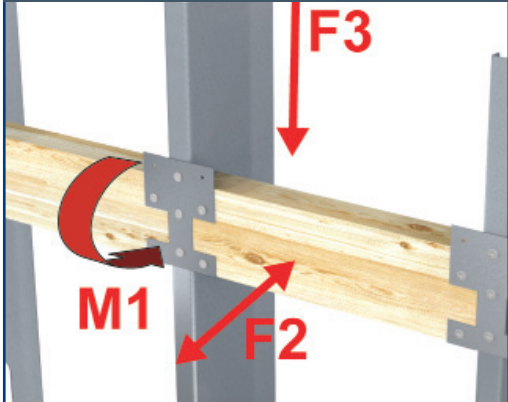

Allowable Loads

IBC (International Building Code) and OSHA (Occupational Safety and Health Administration) load requirements include the ability of wall backing to resist a minimum of 200lbs of concentrated load, or 50lbs per linear foot in any direction. BackIt® satisfies the load requirements in vertical (F3) and horizontal (F2) directions. Extra testing has been done in the rotational (M1) direction. Product test reports are available upon request. Contact TSN Technical Support at (888) 474-4876 for more information.

BridgeClip®

Secures Bridging Channel to Stud

BridgeClip® secures BridgeBar® 150 or 1½" cold-rolled channel (CRC) to stud, resisting both lateral and twisting loads. Tabs on the bottom of a BridgeClip® clamp on the BridgeBar® or CRC, while #10 screws attach the clips to a channel and/or stud through pre-drilled guide holes. Efficient installation is not the only benefit, as BridgeClip® is engineered to accommodate loads that have traditionally been addressed with generic L2x2x16ga.



US Patent #5,904,023

Material Composition

Each BridgeClip® is manufactured from mill certified steel with the following material qualities:

Steel: ASTM A653/A653M, Grade 50 (340), 50ksi (340MPa) minimum yield strength, 65ksi (450MPa) minimum tensile strength, G-90 (Z275) hot-dipped galvanized coating.

Stud Designation	10psf		20psf		25psf	
	Design Wind Pressure and Stud Spacing					
	16" o.c.	24" o.c.	16" o.c.	24" o.c.	16" o.c.	24" o.c.
362S162-33mil, 33ksi	BB / BC1	BB / BC1	BB / BC1	BB / BC3	BB / BC3	N/A
362S162-43mil, 33ksi	BB / BC1	BB / BC1	BB / BC1	BB / BC3	BB / BC3	BB / BC3
362S162-54mil, 50ksi	BB / BC1	BB / BC1	BB / BC1	BB / BC3	BB / BC3	BB / BC3
362S162-68mil, 50ksi	BB / BC1	BB / BC1	BB / BC1	BB / BC3	BB / BC3	BB / BC3
600S162-33mil, 33ksi	BB / BC1	BB / BC1	BB / BC1	BB / BC3 or BC600	BB / BC1	BB / BC3 or BC600
600S162-43mil, 33ksi	BB / BC1	BB / BC1	BB / BC1	BB / BC3 or BC600	BB / BC1	BB / BC3 or BC600
600S162-54mil, 50ksi	BB / BC1	BB / BC1	BB / BC1	BB / BC3 or BC600	BB / BC1	BB / BC3 or BC600
600S162-68mil, 50ksi	BB / BC1	BB / BC1	BB / BC1	BB / BC3 or BC600	BB / BC1	BB / BC3 or BC600
600S162-97mil, 50ksi	BB / BC1	BB / BC1	BB / BC1	BB / BC3 or BC600	BB / BC1	BB / BC3 or BC600

BridgeClip® Value

- Fast installation
- No clamping
- No welding
- Guide holes provided for quick and accurate fastener placement
- Rounded edges for safety
- Laborers are working on installation, not cutting angle
- Mill certified, 50ksi steel, G-90 galvanized coating
- 33 Mil thickness (BridgeClip®)
- 43 Mil thickness (BC600 & BC800)

Allowable Loads

Designation	F1 (kips)	M1 (in.-kips)
BridgeClip® (1) Screw	0.075	0.180
BridgeClip® (3) Screws	0.360	0.340
BC600	0.360	0.720
BC800	0.360	0.720

- Design loads based on clip capacity only (verify screw shear and pullout at stud web).
- Allowable loads have not been increased for wind, seismic, or other factors.

BridgeClip® easily handles up to a 6" stud with 25 PSF loads with only one screw.

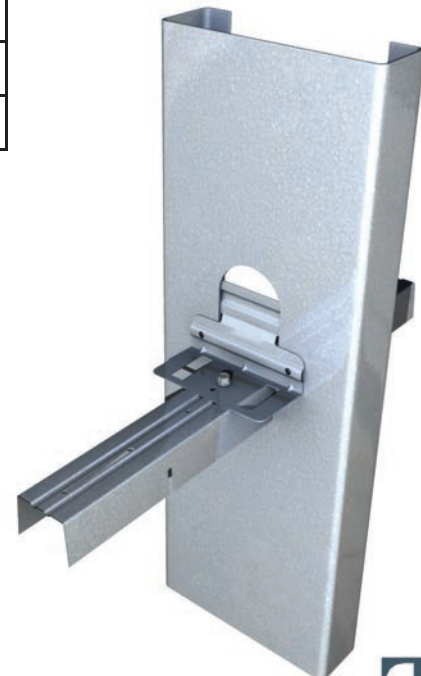

EXTREME^{3.1} LOADING[®] FOR STRUCTURES

Prescriptive VS Performance Based Design

It is widely accepted that using Performance Based Design (PBD) in lieu of a Prescriptive design on projects results in a significant savings to the owner. In several cases projects and/or contracts were won or made possible due to the overall cost savings achieved through PBD.

The resistance to the Performance Based Design is based on the assumption that PBD is complicated, time consuming, and therefore more expensive. Extreme Loading[®] for Structures software (ELS) enables structural engineers to perform complete seismic analyses to show and ensure structures are designed to resist anticipated seismic events. This is accomplished in a fraction of the time when compared with other PBD tools.

ELS is able to simplify an engineer's task of performing dynamic non-linear analysis because of its advanced Applied Element Method (AEM) based solver. AEM is a derivative of the Finite Element Method (FEM) and the Discrete Element Method (DEM), capable of automatically calculating the yielding of reinforcement, plastic hinge formation, buckling & post-buckling, crack propagation, separation of elements, collision, and collapse.

ELS allows designers to look at structures in a way that opens the door to more reality-based design and development. With ELS, engineers are not only capable of analyzing buildings, but all structures such as bridges, stadiums, equipment, secondary systems, etc.

ELS Seismic Analysis Includes:

- Creating a 3D model for the "as-designed" structure based on the available design drawings.
- Performing nonlinear static and dynamic analyses of the structure under the effect of the required cases of loading including seismic and wind loads.
- Comparing the behavior of the "as-designed" structure with the "as-built" structure.
- Checking stresses in all structural components.
- Making recommendations for retrofit to prevent progressive collapse due to seismic activity.

ELS establishes a new standard in Performance Based Design. See www.extremeloading.com for an in-depth look at the tool, applications, research and case studies from around the world.

Contact a representative today to learn more: 1.919.645.4090

www.extremeloading.com

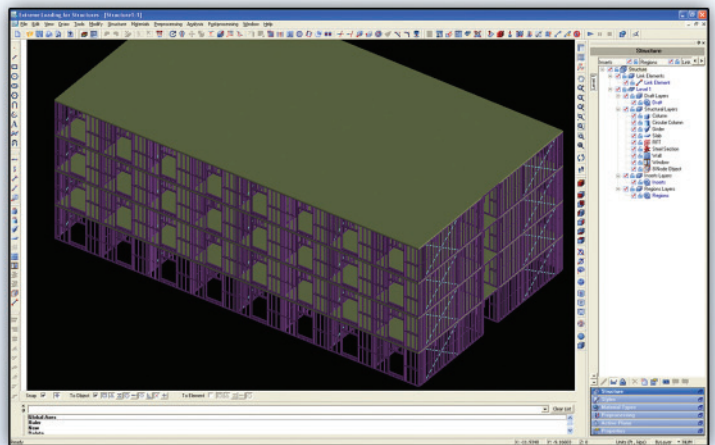
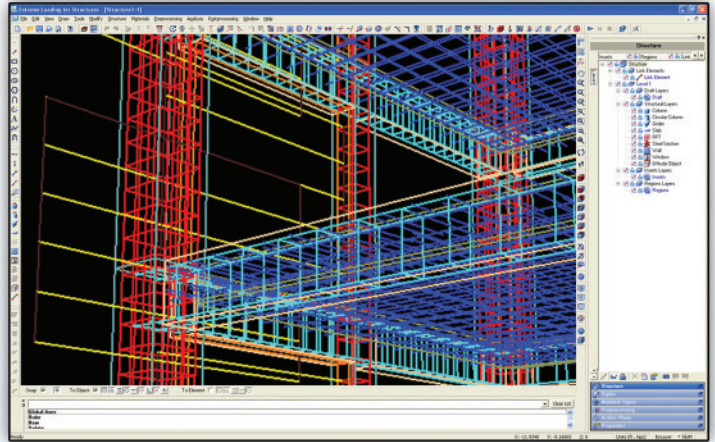

VertiClip®

The Steel Network's VertiClip® products are evaluated by the ICC-ES, ref. ICC-ESR-1903.

Head of Wall



VertiClip® SL

VertiClip® SLD

VertiClip® VTD

Bypass



VertiClip® SLS

VertiClip® SLT

VertiClip® Splice



VertiClip® VTX



An ICC-ES Evaluation Report for VertiClip® SLD600, SL362, SL600, SL800, SLB600, SLS600-15, SLT-9.5, and SLT(L)-18 is available. Refer to ICC-ESR-1903 at www.icc-es.org or at www.steelnetwork.com



VA Los Angeles Research Report for VertiClip® SLD, SL, SLB, SLS, and SLT Series is available. Refer to LARR #25631.



VertiClip® SLB

StiffClip®

The Steel Network's Connections Meet AC261 Requirements, the Newly Established Standard for ICC Testing



StiffClip® HE Header Clip

StiffClip® LB Spandrel Bypass

VertiClip® Splice Multi-Stud Clip

BackIt® Multi-Stud Clip

StiffClip® CL Tie-Down

MidWall™ Partial Wall Framing

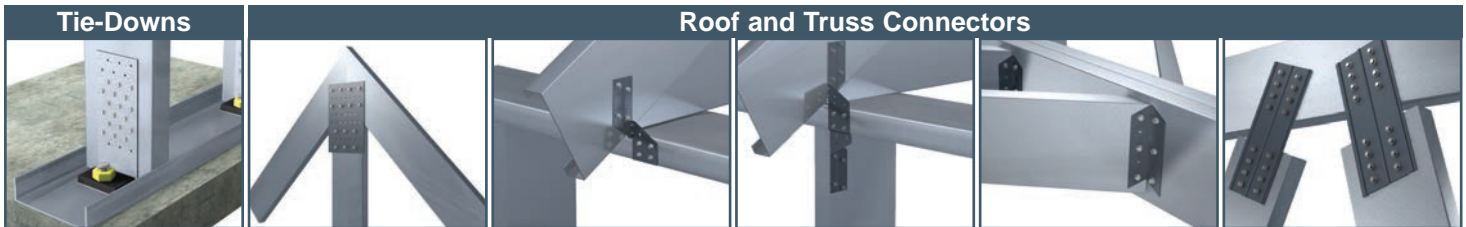

StiffClip® TD Tie-Down

StiffClip® PL Truss Connector

StiffClip® RT650 Roof Tie

StiffClip® RT1300 Roof Tie

StiffClip® HC Hip Connector

StiffClip® WC Web Connector



StiffClip® JH Joist Hanger

StiffClip® JC Joist Clip

StiffClip® FS Floor Strap

StiffClip® LS

StiffClip® AL

Custom Connectors





SteelSmart™ System 6 Software

The SteelSmart™ System 6.0 (SSS) provides construction professionals with an essential tool engineered for both fast and accurate design, as well as providing output to assist in the budgeting of light steel framing projects. Available as a complete suite, SteelSmart™ System will streamline production through the design and detailing of members, connections, and fasteners. Available modules include: Curtain Wall, Load Bearing Wall, X-Brace Shear Wall, Roof Truss, Roof Joist, Floor Framing, and Moment-Resisting Short Wall.



Load Generator and Distributor

The Lateral Load Generator/Distributor tool uses the dimensions and load specification for a building and calculates the total lateral wind and seismic loads according to ASCE 7 Standard "Minimum Design Loads for Buildings and Other Structures". Then, the tool distributes the lateral loads between floors and between shear walls in each floor. The distribution method takes into consideration type of floor diaphragm (rigid or flexible) and torsional effects of rigid diaphragms. The tool exports load data to the SW design module and full output to a standard Excel sheet.

The input data for the building includes overall dimensions and heights, number of stories, roof type and slope, and occupancy category. Wind input data include basic wind speed, exposure and factors related to building enclosure classification, wind directionality and topography. Seismic input data include lateral system category and design coefficients, site classification and coefficients, spectral response acceleration and floor/roof weights to be considered for calculations of base shear.

The 3D viewer shows a three-dimensional view of the shear walls in the building in all orientation and floors.

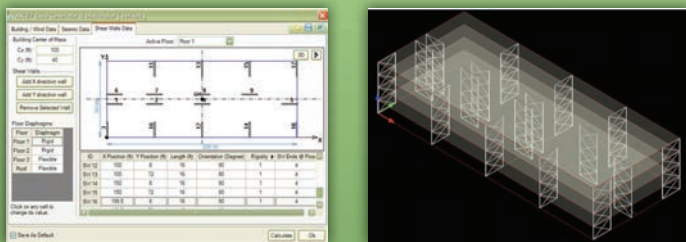

The output lateral seismic data and loads include Seismic Design Category (SDC), building total weight, total base shear, cumulative shear and lateral force at each floor. The output lateral wind data and loads includes lateral positive and negative wall pressures, side wall pressure and roof pressure. It also includes Component and Cladding (C&C) design pressures. All output can be printed in a professional report, exported to a spreadsheet or transferred to the component design modules.

Layout and Connection Details Generator

A major addition to SSS 6.0 is the new Layout and Connection Details Generator that plots framing layout of the wall and adds the connection design data (clip designation, # of fasteners, embedment, and screw pattern) to the typical connection detail. The drawing also includes framing members' cross-sections and shapes. The drawing can be exported in AutoCAD® DXF format.

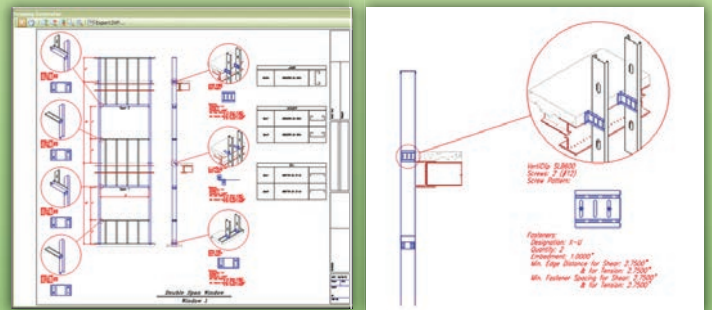

SSS 6.0 provides detailed drawings for the following framing components:

- Curtain wall framing including typical stud, opening framing (jamb, header and sill), bridging, vertical deflection connections, vertical deflection and drift connections, fixed connections and screw and fastener attachment to structure
- Load bearing wall framing including typical stud, opening framing (jamb, header and sill), bridging, fixed connections and screw and fastener attachment to structure
- StiffWall shear wall framing including boundary columns, diagonal straps, corner boot connection, screw and bolt/weld attachment and anchorage to structure



Preliminary Design Services

TSN's value engineering consulting services are available at no charge to the project team, including:

- Plan Review
- Engineered Solutions
- Specification Review
- Project Recommendations
- Final Construction Documents Details
- Specialty Engineering Referrals for shop drawing preparation

Typical results of TSN's Preliminary Design services include:

- Lower project costs
- Material cost savings in the wall system
- Reduction of foundation requirements
- Substantially accelerated construction schedules
- Fewer subcontractors on the job
- Satisfied Developers, Contractors, Structural Engineers, and Architects

Get your cold-formed steel SPECIFICATIONS updated from leading experts at NO CHARGE TO YOUR BOTTOM LINE.

The Steel Network, Inc has initiated several product and code updates. To help keep your light gauge specifications and structural notes current, TSN's technical staff provides a complementary review. Let our team of experts who work daily with CFS specifications and design in the areas of clips and connections, secondary light gauge framing, load bearing walls systems, and framed openings serve your team with up to date product nomenclature and code references. Our team at The Steel Network strives to provide you with excellent technical support for light gauge steel framing. There is no cost to utilize this service if you send your cold-formed steel framing specifications or structural notes to technicalsupport@steelnetwork.com or call 919-845-1025. The review we provide is aimed at controlling cost for owners, protecting liability, leveling the playing field for contractors, and overall making your light steel framed projects safer and efficient.



2012 T.W. Alexander Drive
P.O Box 13887
Durham, NC 27709
919.845.1025
1.888.474.4TSN

6625 Arroyo Springs
Street, Suite 140
Las Vegas, NV 89113
Phone: 702.643.4330
888.474.4TSN

www.steelnetwork.com

Premium Light Steel Framing Connections and Members

SteelSmart™ System
www.steelSMARTsystem.com

Applied Science International, LLC
www.appliedscienceint.com

Extreme Loading®
www.extremeloading.com