

VertiClip® SLT

Structure/Slab Bypass

Material Composition

ASTM A1003/A1003M Structural Grade 50 (340) Type H, ST50H (ST340H): 50ksi (340MPa) minimum yield strength, 65ksi (450MPa) minimum tensile strength, 97mil minimum thickness (12 gauge, 0.1017" design thickness) with ASTM A653/A653M G90 (Z275) hot dipped galvanized coating.

The attachment of VertiClip to the primary structure may be made with PAF, screw/bolt anchors, or weld and is dependent upon the base material (steel or concrete) and the design configuration.

VertiClip® SLT(S)

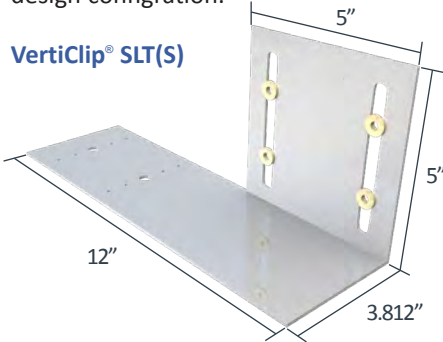

VertiClip® SLT(L)

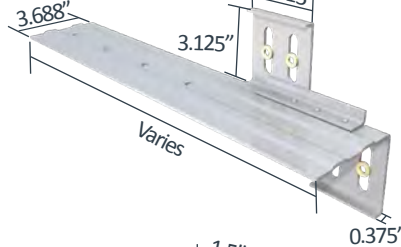

VertiClip® SLT

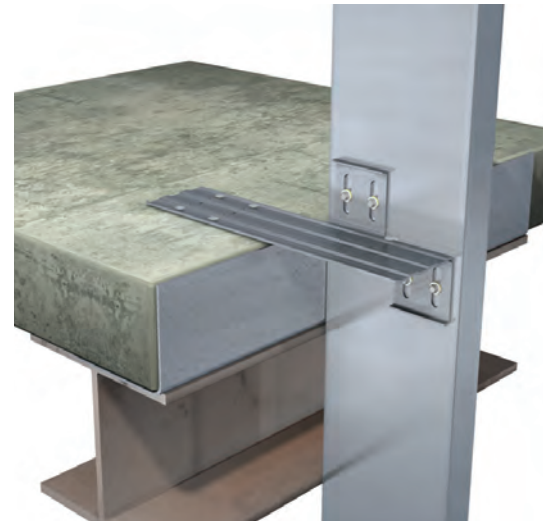
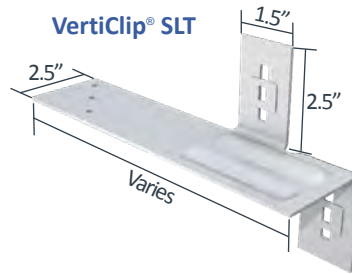

US Patents #5,467,566 & #5,906,080

VertiClip SLT Allowable (Unfactored) Loads*

VertiClip® SLT & SLT(L), Recommended Allowable Load (lbs): F1 & F2											
Stud		F1 Load Direction			F2 Load Direction						
		SLT9.5	SLT(L)12, SLT(L)15 & SLT(L)18	SLT-9.5	SLT(L)12		SLT(L)15		SLT(L)18		
Thickness Mils (ga)	Yield Strength (ksi)	w/2 #12 screws	w/2 #12 screws	w/4 #12 screws	w/2 #12 screws	w/2 #12 screws	w/4 #12 screws	w/2 #12 screws	w/4 #12 screws	w/2 #12 screws	w/4 #12 screws
33 (20)	33	190	190	380	376	376	754	376	744	376	700
33 (20)	50	275	275	452	510	544	903	544	744	544	700
43 (18)	33	248	248	452	510	560	903	560	744	560	700
43 (18)	50	341	359	452	510	810	903	744	744	700	700
54 (16)	33	312	312	452	510	789	903	744	744	700	700
54 (16)	50	341	450	452	510	903	903	744	744	700	700
68 (14)	50	341	452	452	510	903	903	744	744	700	700
97 (12)	50	341	452	452	510	903	903	744	744	700	700
Max Allowable Clip Load		341	452	510	903	744	700	744	700	700	700

VertiClip® SLT(S), Recommended Allowable Load (lbs): F1 & F2					
Stud		F1 Load Direction		F2 Load Direction	
		Back Fasteners	Front Fasteners	Back Fasteners	Front Fasteners
Thickness Mils (ga)	Yield Strength (ksi)	w/4 #12 screws	w/4 #12 screws	w/4 #12 screws	w/4 #12 screws
33 (20)	33	191	191	381	381
33 (20)	50	275	275	550	550
43 (18)	33	248	248	566	566
43 (18)	50	330	282	818	818
54 (16)	33	330	282	796	796
54 (16)	50	330	282	890	917
68 (14)	50	330	282	890	917
97 (12)	50	330	282	890	917
Max Allowable Clip Load		330	282	890	917

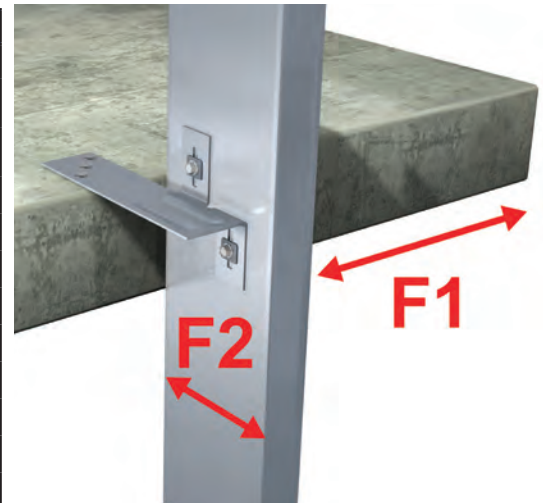

****Important notes for VertiClip SLT Allowable Load tables continued on next page.**

Table Notes:

- VertiClip SLT series is designed to support horizontal loads and must not be used in axial-load-bearing wall construction.
 - Allowable loads have not been increased for wind, seismic, or other factors.
 - #12 screws are provided with each Step Bushing.
 - VertiClip SLT & SLT(S) allow up to 2" of vertical deflection (1" up and 1" down).
 - VertiClip SLT(L) allows up to 1.875" of vertical deflection (0.938" up and 0.938" down)
 - VertiClip SLT(S) Recommended Allowable Loads are based on 4 #12 screws at the stud attachment and either front or rear fastener attachment at the structure respectfully.
 - Torsional effects are considered on screw group for F2 allowable loads. All torsion attributed to screws, none to the clip connection to structure.
 - VertiClip SLT is recommended to have for steel attachment a ½" minimum edge distance from fasteners and for concrete attachment a 2 ¼" minimum edge distance from fasteners.
- † For LRFD Design Strengths refer to ICC-ESR-2049.

Nomenclature

VertiClip SLT is available in a length of 9 ½". VertiClip SLT(S) is available in a length of 12". VertiClip SLT(L) is available in lengths of 12", 15", and 18". Determine length by adding stud + offset + 3" for steel (5.5" for concrete) and selecting the next largest size.

Example: 6" stud, 4" offset + 3"
Designate: VertiClip® SLT(L)15

Example Details



VertiClip SLT attached to the underside of wide flange beam.

VertiClip SLT(S) Fastener Patterns

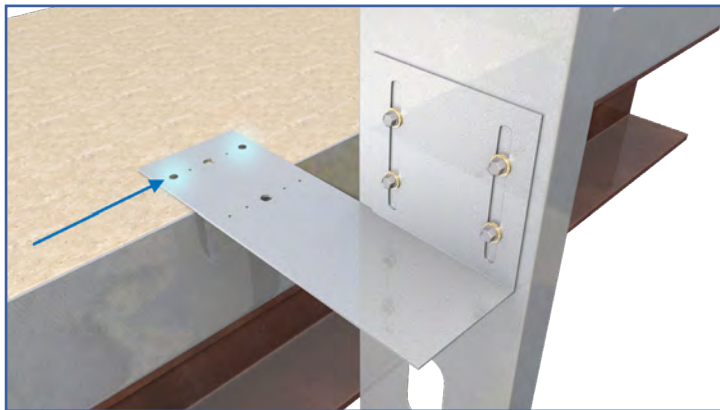

Back Fasteners Attachment to Structure

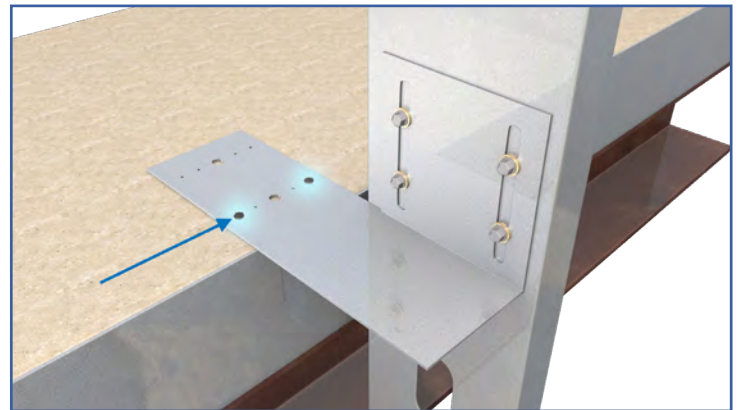

Front Fasteners Attachment to Structure



VertiClip SLT 9.5 & SLT(L)-18
 ICC-ESR-2049
 www.icc-es.org

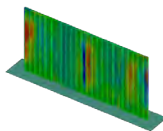

VertiClip SLT Series
 Blast and Seismic Design Data
 www.steelnetwork.com

** For more information or to review a copy of each of these reports, please visit our website at <http://www.steelnetwork.com/Site/TechnicalData>